

Drawings / Zeichnungen:
ArciTech

Technik für Möbel

Hettich

Model / Ausführung	Drawer / Schubkasten
Profile height / Zargenhöhe	94 mm
Nominal length / Nennlänge	270 mm
Cabinet side panel thickness / Korpuseitendicke	16 / 18 / 19 mm

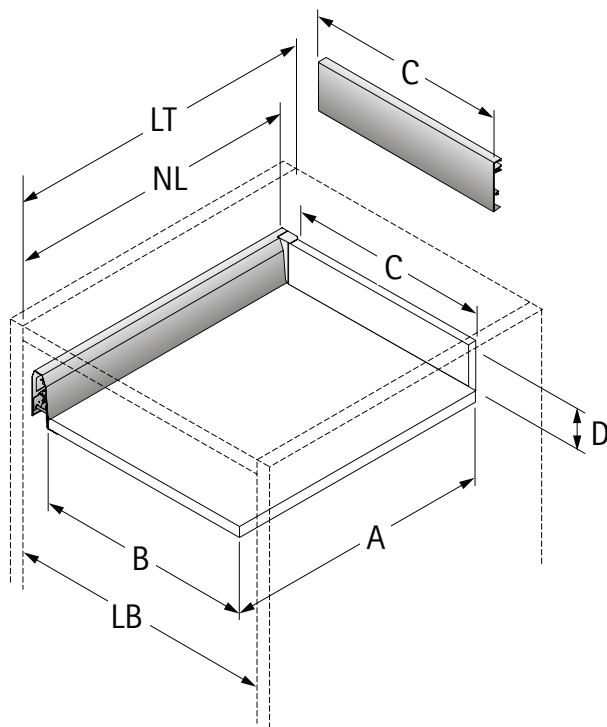

Measurement / Maß	Steel rear panel / Stahlrückwand	Wooden rear panel / Holzrückwand	Aluminium rear panel / Aluminiumrückwand
A	249	245,5	245,5
B	$LB - 2x EB - 52$	$LB - 2x EB - 52$	$LB - 2x EB - 52$
C	-	$LB - 2x EB - 63,5$	$LB - 2x EB - 63,5$
D	-	84,5	-

Note: For Push to open applications the minimum cabinet depth increases by 12 mm.

Achtung: Bei der Verwendung von Push to open erhöht sich die Mindestkorpustiefe um 12 mm.

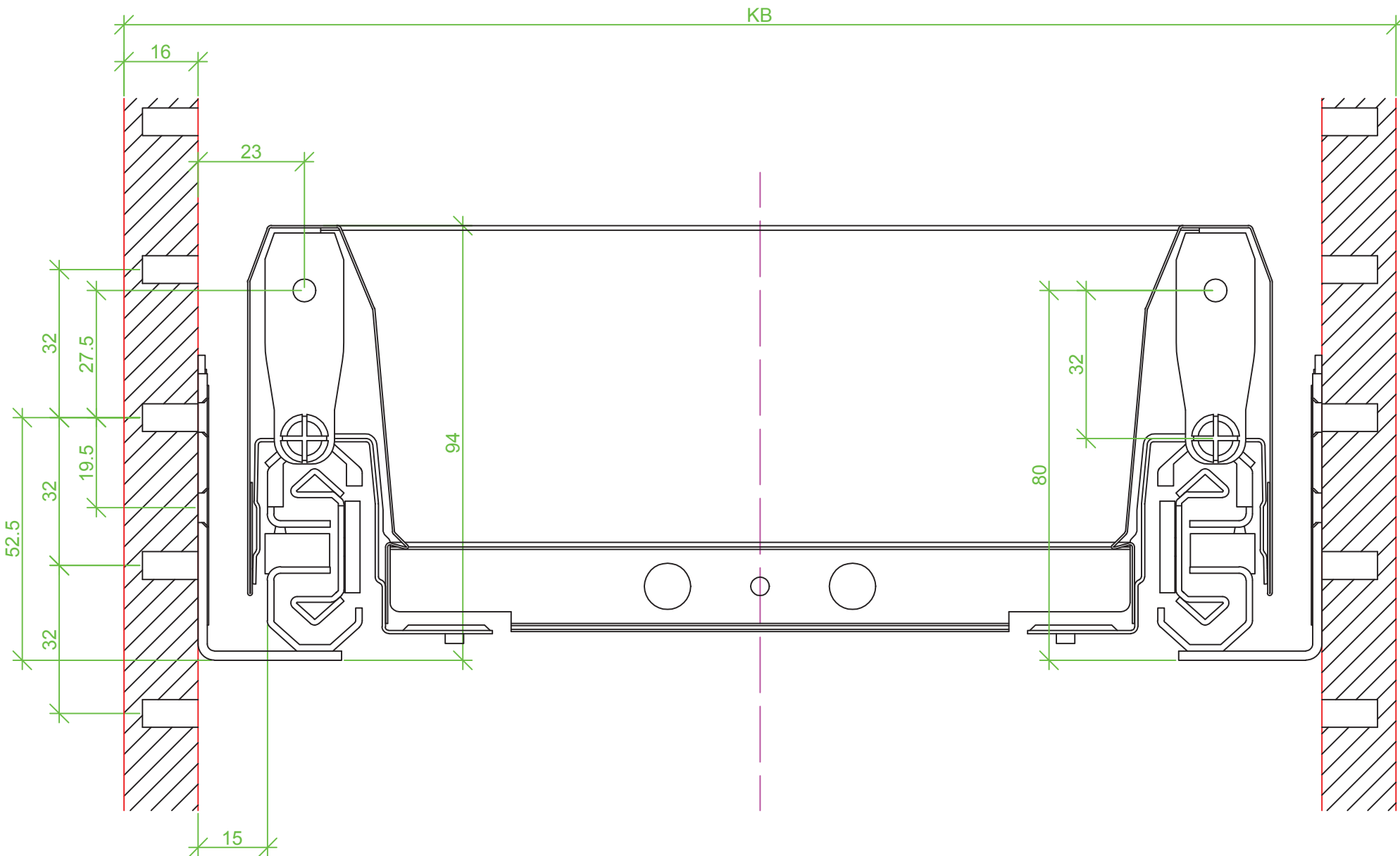

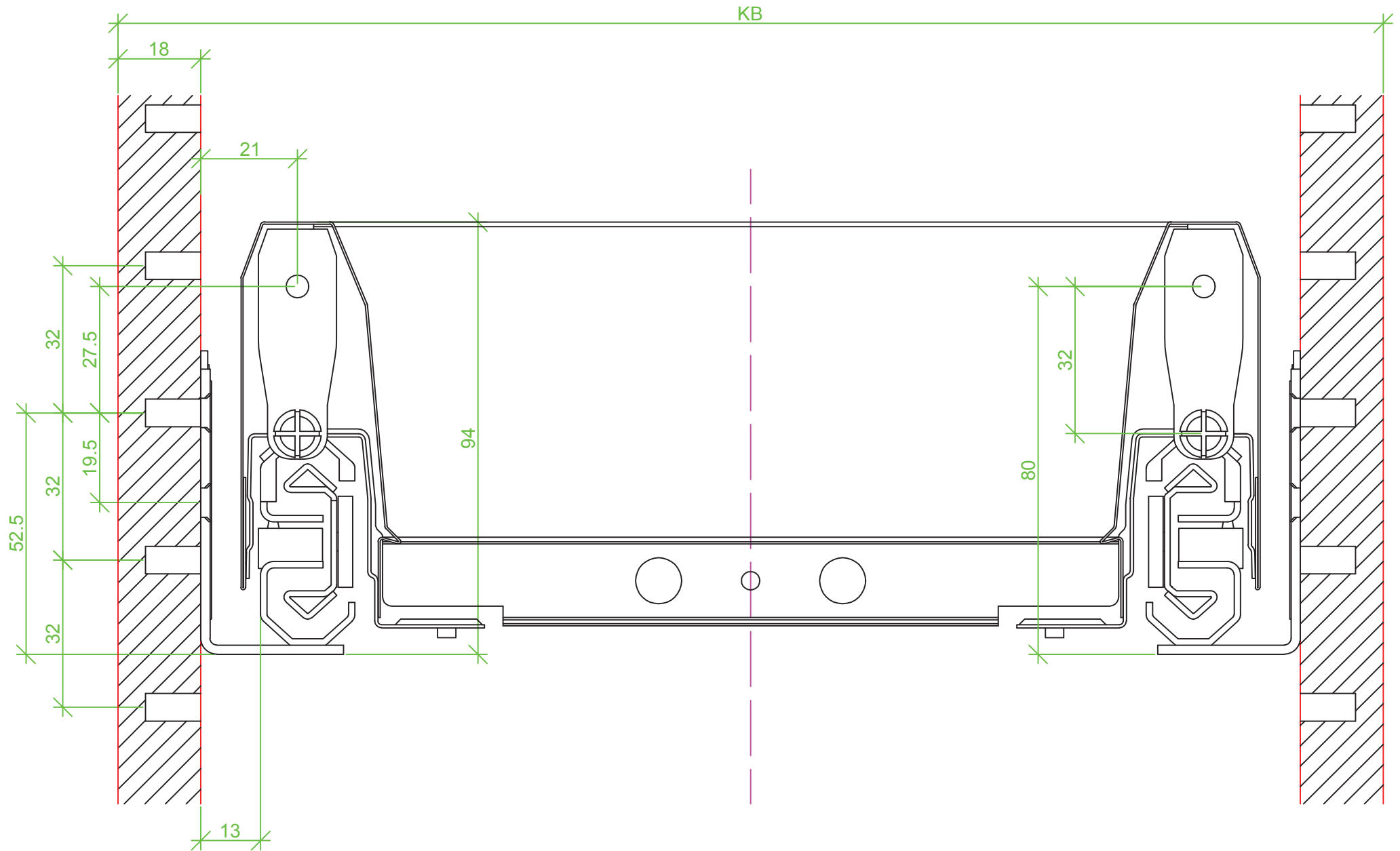

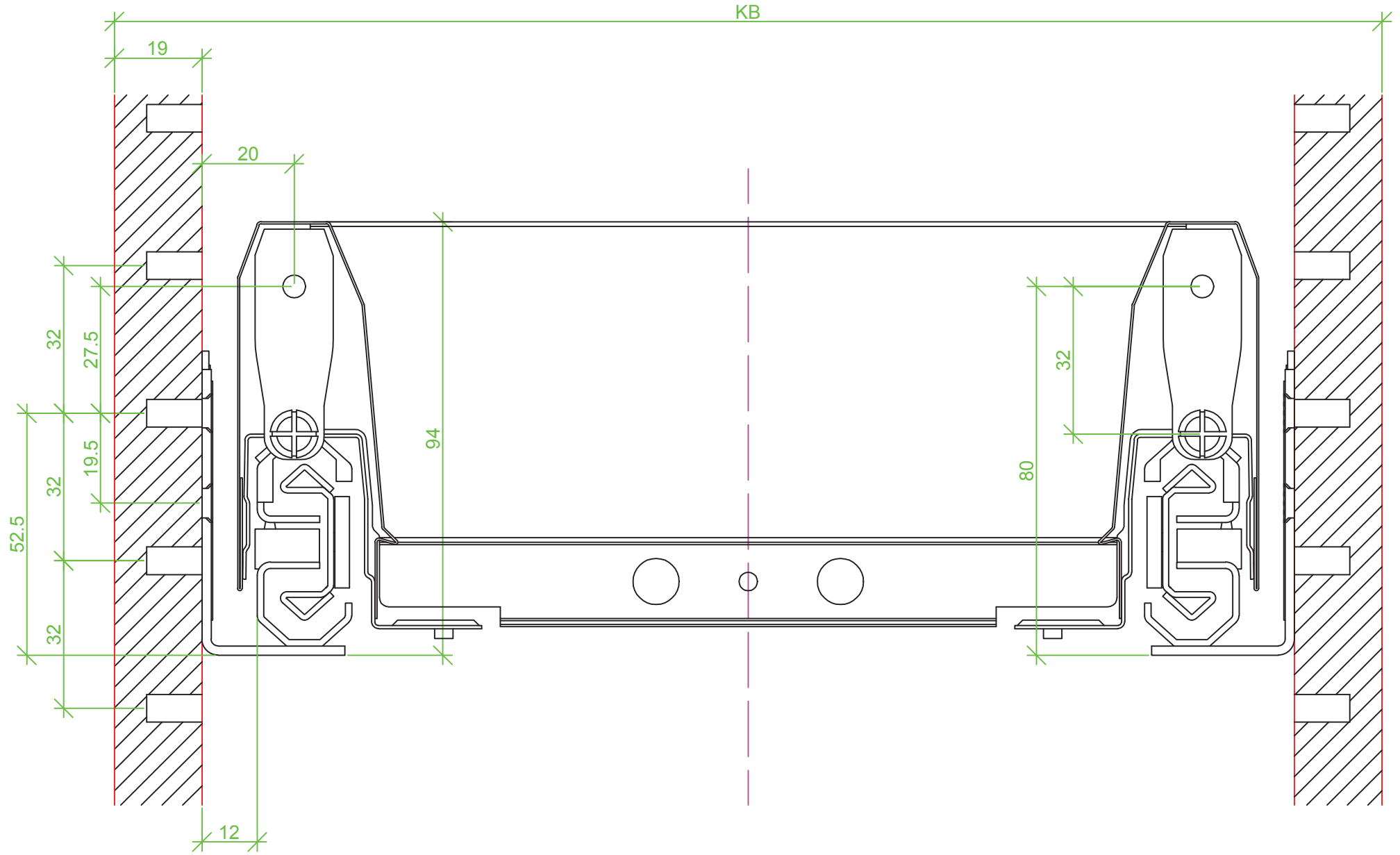

Sideview / Seitenansicht

